

STEULER Surface Protection | Linings

SURFACE PROTECTION LININGS

PROTECTING PERFECTLY

FOCUS ON PROGRESS



Our specialists support you on site – so that your project runs smoothly from start to finish.



Not always visible, but always present – tailor-made corrosion protection for your plant.

CONVINCING SOLUTIONS

SHAPING THE FUTURE. FOR OVER 110 YEARS.

The Steuler Group stands for innovative materials, new technologies and their constant development. With specialized business segments and the divisions Linings, Equipment Engineering and Tiles, the Steuler Group is a successful international company - at 25 locations around the world.

Our growth is something we've systematically and vigorously pursued ever since the company's founding over 110 years ago. With ground-breaking in-house developments, we've opened the door to completely new dimensions and production possibilities for process engineering projects in the chemical industry. And over 2,600 employees around the world help us pursue this successful course each day.

The „hidden champion from the Westerwald“ is how our customers refer to us. And we're proud of the fact. It motivates us to continue.

ALWAYS A STEP AHEAD.

NUMEROUS PATENT AND TRADEMARK APPLICATIONS.

Both our drive to performance and our vitality are the foundation for the successful evolution of our medium-sized family company, now in its fourth generation, since its founding in 1908. This is complemented by experience, expertise and creativity to create sustainable, creative solutions. We respond quickly and precisely to the continually changing market conditions and requirements of our customers.

We deliver more than just the proven routine. Our goal is to offer novel solutions, always go a step further and shape the future. With our many patents and brands we are the innovation driver of the industry.

And we want to build on this lead. For the benefit of our customers. With new ideas and innovative solutions.

What challenges can we solve for you?

We look forward to talking with you about them.



WE EXPAND YOUR HORIZONS

**CREATIVE SOLUTIONS WITH CHEMISTRY AND
PHYSICS. INDIVIDUAL AND TAILOR-MADE.**



The teams of experts in our development departments draw on their expertise to come up with innovative solutions for your problem.

Design and technology are the unique fingerprints of the plant engineer. They are the expression of their philosophy.

The Steuler fingerprint is the product of analysis, precision, creativity, individuality and efficiency – interdisciplinary excellence from a single source. The end result is corrosion protection concepts and designs that are perfect in every detail: technically, economically and ecologically. Incorporating the pooled knowledge and experience of our experts.

Our corrosion protection linings are always made-to-measure. We manufacture each one specifically for the project in question. Special attention is given to unusual geometries, application-specific specifications and maximum durability under chemical, physical and mechanical loads. We combine materials and technologies to create a near infinite number of possible solutions.

Precisely custom-fabricated, the form and function of every element is essential for their safe and reliable use and service. Off-the-shelf products, on the other hand, only offer average performance and are difficult to adapt to specific requirements.

NOT OFF-THE-SHELF

We develop and manufacture the materials ourselves. The research and development, application technology and production departments work hand in hand. Their goal is always to create a product- and project-specific solution. Steuler rarely offers „off-the-shelf“ solutions.

Our engineering and production departments provide efficient and effective materials for the application in question. Or if necessary, develop them from scratch. In doing so, the focus is on achieving the longest possible safe service life and optimal plant availability for our customers.

Delivering the right material and the optimal design is always the result of effective dialogue with our customers and taking into account all of the parameters. We then provide the right material for the job in question.

We can even supply the most unusual lining solutions, as required. Tailor-made in every detail. State-of-the-art production facilities ensure the necessary level of flexibility, even for small batch sizes.

In short: We supply novel, precisely tailored solutions. „It's the way we've always done it“ is not something you'll hear from us.



Opto-electronic dimensional inspection in ceramic brick production – ensuring that everything fits afterwards.

INDUSTRY-SPECIFIC AND SPECIAL SOLUTIONS

Every product group serves its particular market with distinct technologies and high-quality solutions. Together, they create a unique unit for comprehensive industry-wide solutions or specific industry sectors. Everything from a single source – coordinated and matched, project-managed and implemented – for numerous requirements of entire industry sectors – as well as special requirements.

Together with its international subsidiaries and agencies, Steuler has a global network that successfully exploits the potential of this portfolio.



WE WORK HARD,
ACCORDING TO PLAN.
MAKING SURE IT FITS.
PERFECT TEAMWORK AT EVERY LEVEL.

Steuler ensures efficient coordination across all project levels and in all project phases. From the first contact to acceptance of services and deliverables. And we are able to perform every service in between according to your specifications: Lining calculations and properties, materials and formats, supply and assembly. Perfectly coordinated like in a precision clock.

Everything remains in our highly capable hands, from the planning engineers to the installation technicians on site. Our highly skilled and experienced Steuler technicians ensure that all the engineering specifications are properly implemented. With a trained eye for the important details. And without losing sight of the big picture.

EFFICIENT PROCESSES ENSURE DEADLINES ARE MAINTAINED.

Technical consultation and coordination of works are carried out exclusively by experienced Steuler specialists. They work within an international quality assurance and management system. Steuler is there as your expert partner from the initial consultation to project execution.

A project team plans and coordinates the perfect implementation: Always in close coordination between the production and installation departments, with installation instructions to the installation team, with project supervision on site and professional processing of the products.

Our efficiency in project management and project logistics offers you on-time realization. An important aspect for you is our reliable work scheduling: Materials, equipment and personnel at the right place at the right time – world-wide. Dependable installation times ensure your production operation. This is time won for your success.

Everything so that it fits perfectly. And everything from Steuler.



Whether providing supervision or installation with in-house technicians – Steuler's specialists are your guarantee for reliable installation.



Complex corrosion protection services for power stations.



Innovative solutions for high thermal loads.

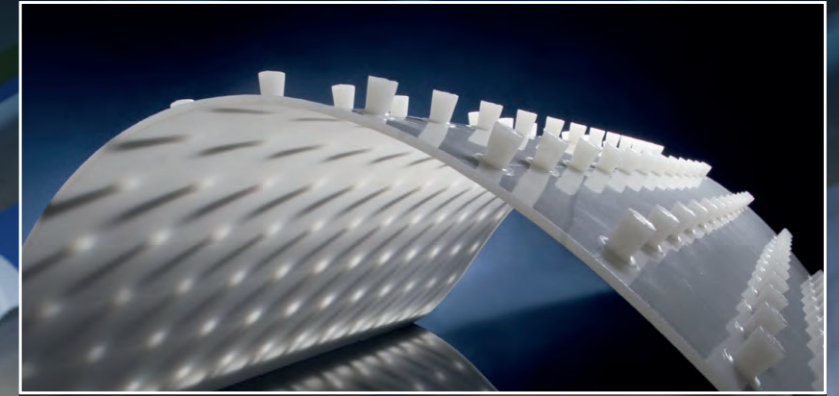

Intelligent protection with plastic systems.

THE STEULER LININGS- PORTFOLIO

COMPLETE SOLUTIONS A UNIQUE ENTITY.

Steuler is a global supplier of industrial linings. The company always supplies complete solutions, from consultation on planning and design of corrosion and surface protection measures and professional processing of the materials through to performing the construction and installation work on site.

The product portfolio of **Steuler Surface Protection Linings** comprises coatings and rubber linings, brick linings and tiling systems for every industrial surface and corrosion protection requirement.

Steuler Plastic Linings supplies pipes, vessels and equipment for environments subject to high chemical, thermal and mechanical loads. They may be manufactured from pure thermoplastic or glass-fibre reinforced plastics with or without liner, or from a fibre-reinforced phenolic resin material. They offer reliable and long-lasting durability.

Steuler Refractory Linings is a global market leader and driver of innovation in the field of refractory lining systems. Its portfolio includes both shaped and un-shaped refractory products. Dense, thermally, chemically and mechanically resilient or light, insulating materials – as a full-service supplier, we provide all the refractory materials necessary for the lining, including complete anchoring systems.

PRODUCT GROUP

BRICK LININGS AND TILING SYSTEMS

Steuler's success story began over 110 years ago with the development of the world's first acid-resistant cement. This archetypal cement was the basis on which a comprehensive range of highly resilient products was developed, that today make lining systems for process vessels and equipment in every conceivable industry sector possible.

IT ALL STARTED WITH THE ORIGINAL CEMENT.

Steuler systematically developed and improved its product portfolio further. As a result, we can handle even the most complex and modern plant technology of our customers.

We combine sealing membranes, cements and ceramic materials to create solutions that are perfectly tailored to your project requirements. Besides being able to draw on our extensive range of existing materials, we can also develop new solutions with our development department, whenever needed. This ability allows greater scope for your project.

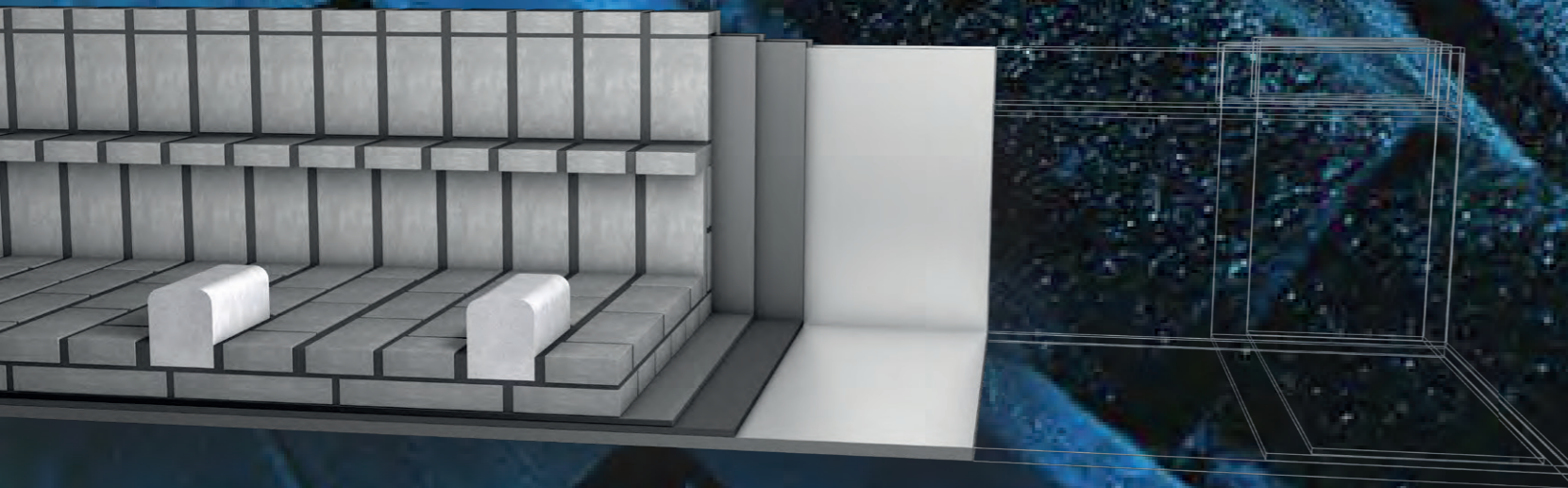

Steuler is your experienced partner for brick linings. Whether it involves pickling or acid regeneration plants, vessels, flue gas ducts or reactors, venturi scrubbers, autoclaves or absorption towers – we're the experts. In theory and practice. This is what we draw on when selecting the lining system for the process in question and advising you on the possible options. As a specialist in the field, we naturally offer custom solutions too. We can also draw on a wealth of original technical know-how: For example, when it comes to high temperatures, autoclaves and pressure vessels.

The professional installation of our brick linings is always part of the package. Perfect service from a single source.

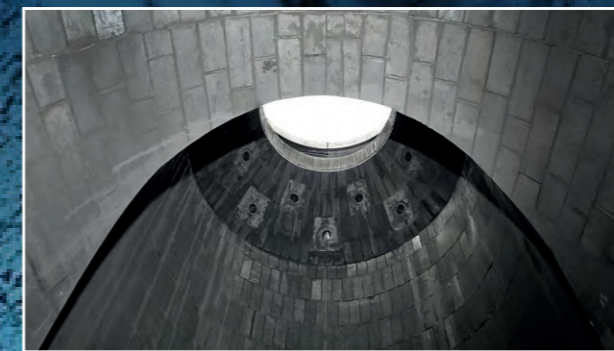

System lining with carbon bricks.



System lining with ceramic bricks.

WITHSTANDING THE MOST EXTREME DEMANDS

Brick linings are subject to extreme stresses due to exposure to particular media or a combination of different media:

Chemical stress

- > Chemical attack by media in liquid, gaseous or solid states

Thermal stress

- > Temperature level and temperature distribution
- > Temperature differences between the individual layers of the brick lining and the environment
- > Thermal cycling
- > Different coefficients of thermal expansion of lining materials and structure

Mechanical stress

- > Pressure ratios
- > Vibrations
- > Abrasion
- > Impact stress
- > Traffic

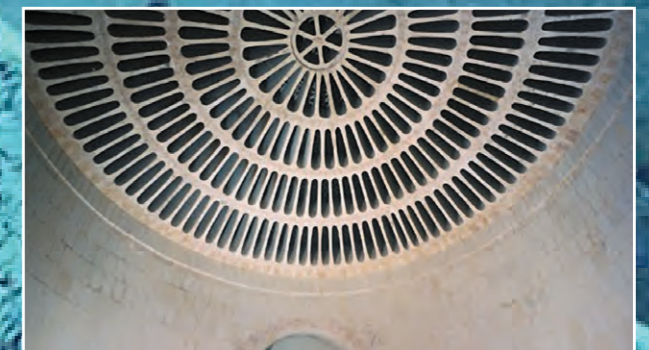

Self-supporting stepped dome grid in a absorption tower.

PRODUCT GROUP BRICK LININGS AND TILING SYSTEMS

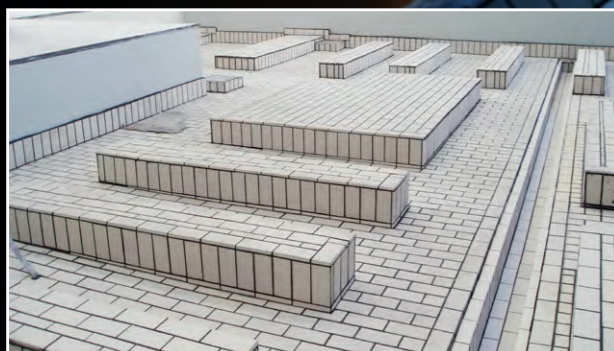

Combined lining system composed of sealing membrane and ceramic tiles in a containment basin.

PROTECTION AGAINST EXTREMES

For decades now, the liquid-phase oxidation process has been used in the mining industry, amongst others, to remove sulphur from ores. Specially developed brick linings are a tried-and-tested way of protecting the process equipment used, such as autoclaves, flash vessels and quench towers, against the extreme stress profiles encountered.

When designing the lining, its low elasticity within a relatively high elasticity steel vessel must be taken into account. Steuler has the equipment and data necessary to calculate the thermal expansion and also expansion due to pressure of steel vessels, as well as the linear thermal expansion and chemical expansion of the brick lining. Abrupt temperature changes and decreases in pressure do not occur under normal operating conditions, but their effects should be accounted for in the engineering analysis. Finite element (FE) models and painstaking research and development of the brick lining materials are the way to successfully master the complex engineering of pressure vessels (temperature: 150 - 220°C, pressure: 5 - 28 bar).



Chemically resistant hexagonal tile surface.

EXAMPLE FLUE GAS TREATMENT

High gas temperatures, sulphur compounds, phosphoric acid and highly aggressive hydrofluoric acid require suitable lining materials and experienced detail engineering for the various stages of the plant process and critical areas, such as inlets and outlets.

Membranes made from rubber, Rhepanol or synthetic resin systems tend to be employed. Insulating fire bricks, foam glass and acid-resistant ceramics are used as insulation in the various process zones. Where fluoride compounds and hydrofluoric acid are encountered, carbon bricks can be used to reliably protect against chemical attack and higher temperatures. We also offer refractory bricks for use in converters and other special areas.

As a turnkey supplier, Steuler takes care of all the engineering work, material deliveries and installation work here too.

OVERVIEW BRICK LININGS

- > Sealing membrane based on PU, epoxy resin, polyester resin (unsaturated), vinyl ester resin, furan resin; custom formulations; rubber linings; thermoplastics
- > Synthetic resin cements based on furan resin, phenolic resin, polyester resin (unsaturated), vinyl ester resin, various water glass cements; custom formulations
- > Normal bricks, shaped bricks and special formats in various grades (acid-resistant ceramic, graphite and carbon bricks, refractory materials)

Rubber offers two decisive benefits when it comes to heavy-duty corrosion protection: Being a soft rubber lining, it is flexible and conforms very well to structures that „live“. In addition, rubber linings are highly impervious and reliably protect against exposure to liquids and even gases.

Steuler rubber linings offer optimal protection for steel constructions, such as vessels, pipes, process towers, and gas scrubbers and even concrete structures, such as those found in water treatment plants. They resist the chemical effects of acids, bases, salt solutions and water vapour – even at elevated temperatures and when subject to temperature fluctuations. These rubber linings can withstand mechanical loads, such as pressure and abrasion, within a defined range too.

PRODUCT GROUP RUBBER LININGS

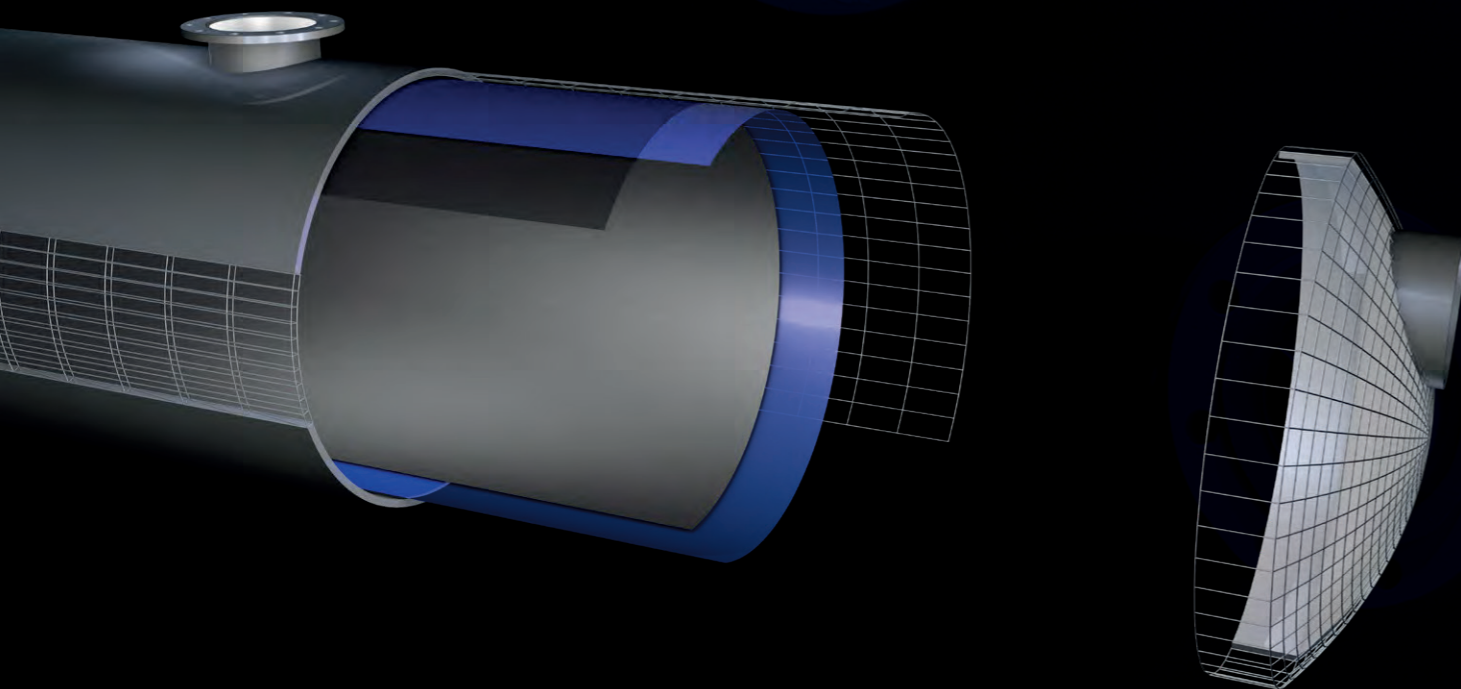

STEULER ON-SITE RUBBER LININGS

Self-vulcanising rubber strips, quick to install, pre-vulcanised grades, rubber linings that achieve standards of adhesion, jointing and resilience comparable to factory-fitted linings using hot water or steam on the building site.

STEULER WORKSHOP RUBBER LININGS

Workshop rubber linings are lining systems that are applied in an un-vulcanised state and then vulcanised by Steuler in its autoclaves under elevated pressure and temperature using steam or hot air. Workshop rubber linings offer optimal protection for plant units, such as process vessels, pipes, quench towers, venturiers, pickling tanks or installed components (drums, nozzles or rollers etc.). We offer both hard and soft rubber linings for this purpose.

STEULER RUBBER LININGS WITH GENERAL APPROVAL OF THE GOVERNMENT (DIBT)

Steuler also manufactures rubber linings with technical approval from the German Institute for Building Technology (DIBt) for use as a liquid tight membrane for application in waters protection.

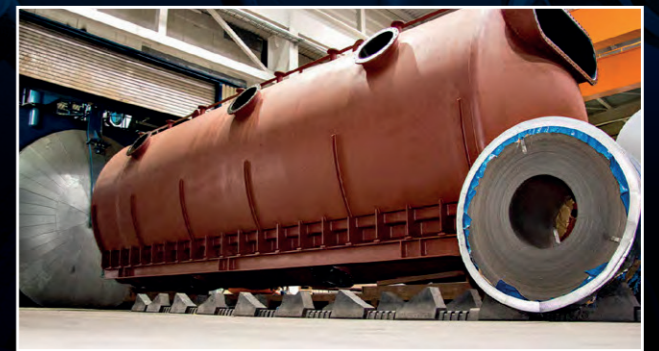

Rubber-lined steel tanks after vulcanisation in the autoclave.

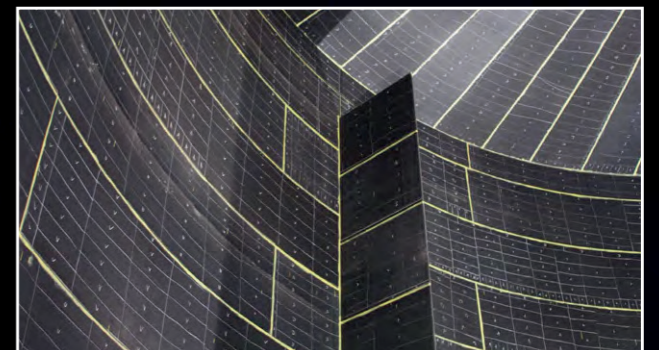

Rubber lined vessel with agitator.

SEAL AND PROTECT.

WHEN EXPOSED TO HEAT, COLD AND PRESSURE.

Steuler produces and works with an extensive portfolio of materials and rubber grades. This means we always have the ideal materials for the requirements and applications in question:

- > long-lasting, reliable chemical, thermal and mechanical resistance and impermeability
- > specified thickness of the sealing membrane
- > non-stick properties and decontaminability
- > resistant to ageing, good crack-bridging properties
- > accurate, repeatable leak testing possible using high-voltage detection technique



Controlled conditions: Installation of a workshop rubber lining.

PRODUCT GROUP RUBBER LININGS



Rubber lining in a flue gas scrubber.



Application of a rubber lining.

When it comes to selecting the right material, we take several criteria into account: Chemical resistance to attack by hydrolysis or oxidation, for example. The ability to withstand permeation processes when exposed to aggressive media constantly or for extended periods of time. This is particularly relevant for chemicals with a small molecular size, such as hydrogen chloride, ammonia or water. And this applies to operating temperatures above ambient temperature too, because permeation processes become more rapid as temperatures rise.

OVERVIEW RUBBER LININGS

- > Rubber linings for steel and concrete structures based on rubber: Butyle (IIR), bromobutyle (BIIR), chlorobutyl (CIIR), Chloroprene (CR), Hypalon (CSM), natural rubber (NR) and speciality grades
- > Autoclave rubber linings Steuler can supply including the steel components too, if desired
- > self-vulcanising or pre-vulcanised, hot water varieties

With our own designs and materials developments as well as trained installation specialists, Steuler is an expert when it comes to the protection and safety of operating areas and other important spaces. Our flooring systems offer long-term safety and practical solutions for your particular requirements. They are designed as a system and applied as such. We

work methodically. With all the specified design details and functional layers tailored to the project in question. By choosing Steuler, you're engaging a coatings' expert who will cost-effectively make your floors and other surfaces safe in the long term.

PRODUCT GROUP FLOOR COATINGS

Steuler offers this custom solutions: Floor coatings and acid-resistant tiles that protect the concrete substrate against corrosive attack and prevent chemicals and harmful substances penetrating the ground thus helping maintain the value of the plants. Tried-and-tested solutions for expansion joints, channel joints and features as well as sealing details of foundation plinths and factory structures complete our floor systems portfolio.

Temperature fluctuations, moisture, chemical attack, the movement of heavy loads, scratches during production or maintenance work – the industrial floors from Steuler can reliably take the punishment. Special surface properties, such as surface planarity and anti-slip properties improve operational processes and increase work safety. In many industry sectors, additional properties such as the ability to safely discharge electrostatic build-up, impermeability to liquids, colour combinations, physiological inertness, high crack-bridging capability or vapour permeability are required.

We can do all this too.



Floor coating in a chemical plant.



Floor coating with ESD protective function for the electronics industry.

COATING, METHODICALLY PERFORMED. FUNDAMENTALLY.

We know that quickly applying a simple, closed synthetic resin coating simply covers up problems. Steuler has never been superficial. On the contrary.

We do it properly out of principle: We plan and produce the entire structure with precisely defined, specifically matched functional layers.

We see and understand the damage that occurs due to the application of unsuitable, superficial coatings. Instead, we offer tried-and-tested constructive solutions for every detail, on-site assemblies and the specific peculiarities of each project.

And we do the same for complex refurbishment projects too.



Leak testing of a chimney coating.



Spray application of a coating with barrier fillers.

OVERVIEW COATINGS

- > extensive selection of primary bonding agents: polyurethane, epoxy resin, vinyl ester resin, polyester resin (unsaturated), furan resin, special formulations
- > various application methods: Trowel-applied coatings, self-levelling coatings, broadcast coatings, laminated coatings, synthetic resin screeds
- > building authority approved membrane systems for all test groups of the DIBt and other media
- > external test certificates for various properties: chemical resistance, crack-bridging, navigability and static dissipation capability
- > special systems with a focus on particular properties: clean room coatings, coatings for the food processing industry, coatings for EPA zones (ESD protection)
- > coordinated system of layers (primers, bonding and levelling layers, intermediate layers, top and wear coats, sealants) with a variety of filler and reinforcing materials

EXAMPLE CUSTOM FLOOR COATINGS

The exact analysis, the mechanical stress and the required efficiency of the substrate determine the individual components and the system structure of the floor coating or covering. Special requirements on the part of our customers are the rule.



Special floor coating: Functional coating in a TV studio.

PRODUCT GROUP (FLOOR) COATINGS

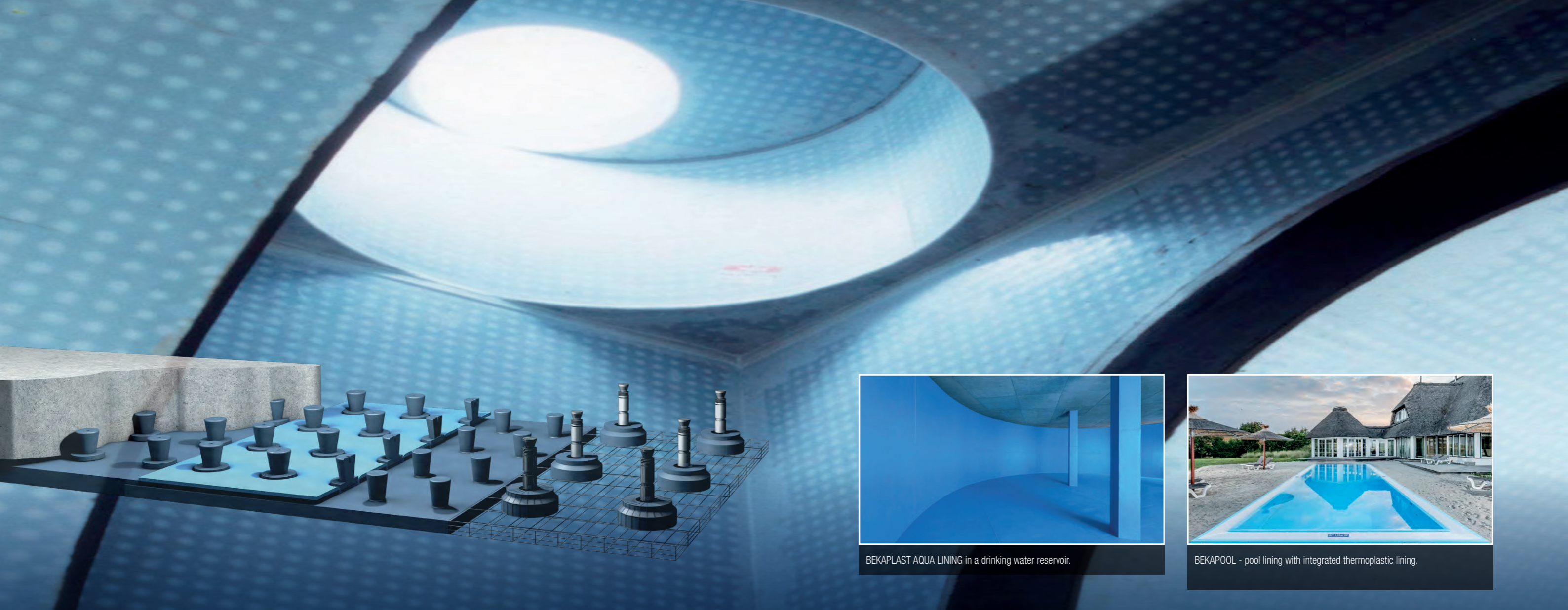

PRODUCT GROUP BEKAPLAST

What seems rather dull at first look, is actually exciting and impressive at second glance. And innovative too.

It starts with the physical anchoring system: The size, shape and arrangement of the studs are the result of intensive development work with the aim of achieving the best possible anchoring of the plates. And we succeeded in our aim. The quality of the anchoring ensures the long-term, reliable functioning of the lining.

An outstanding feature of the system is its flexibility in terms of application. Whether you're planning a new construction or refurbishing a used plant component, the Steuler system allows you to plan the application in advance and thus reduce amount of time spent on site to a minimum.



BEKAPLAST AQUA LINING in a drinking water reservoir.



BEKAPOOL - pool lining with integrated thermoplastic lining.

FOR NEW CONSTRUCTION PROJECTS AND REFURBISHMENTS

Parts with complex geometry are prefabricated in our workshop and installed on site „in one piece“. This reduces the amount of detail work needed on the building site. It also allows fittings to be constructed in workshop quality. In the case of new constructions, large-scale pieces can be directly integrated in the formwork. This helps keep things moving forward and reduces the overall construction time significantly. In the case of refurbishments, we can reduce your downtime to minimum.

When it comes to refurbishments, the possibilities offered by our mechanically anchored plastic plate system are virtually limitless. Whether the substrate is mineral based or made from steel, we have specific solutions for anchoring the system in every substrate. The only requirement is that the structure itself is stable. Time-consuming repairs of the substrate are often unnecessary.

Apart from being able to protect against chemical attack and thermal and mechanical stress, our mechanically anchored plastic plates can be used to satisfy the highest standards of hygiene, such as protecting drinking water reservoirs. The drinking water compatibility, robustness and hygienic surface of the system offer the best prospects for a long-term, reliable and clean solution in this area too.

Because we have a variety of different base plastics at our disposal, we can come up with the optimal technical solution to new requests, challenges and projects as they arise. Steuler has already successfully installed a modified version of the mechanically anchored plates in the swimming pool sector. Tailor made. And successful.

STEULER

Surface Protection | **Linings**

Together with international subsidiaries and representatives, Steuler offers a worldwide network to our clients that develops and implements comprehensive system solutions.

Alphaplast, S.L.U.

Spain

CIMA S.r.l.

Italy

Ditescor S.A. de C.V.

Mexico

STEULER-KCH Polska Sp.z o.o. Poland

**Shanghai STEULER-KCH
Anticorrosion Engineering Co., Ltd.**

China

STEULER Chile SpA

Chile

STEULER-CTI N.V.

Belgium

STEULER-KCH France SARL

France

STEULER-KCH AUSTRALIA Pty. Ltd.

Australia

STEULER-KCH MAROC SARL

Morocco

STEULER-KCH Nordic AB

Sweden

STEULER-KCH Saudi Co. LLC.

Kingdom of Saudi Arabia

Steuler Técnica, S.L.U.

Spain

**TECNICAS DE REFRACTARIOS,
S.A.U. (TECRESA)**

Spain

STEULER-KCH GmbH

Berggarten 1

56427 Siershahn | GERMANY

Phone: +49 2623 600-221

E-Mail: surface-protection@steuler-kch.com

www.steuler-linings.com